

TECHNICAL
ORDER NO. **1-F-15E-1**

15 JULY 1986
CHANGE 6

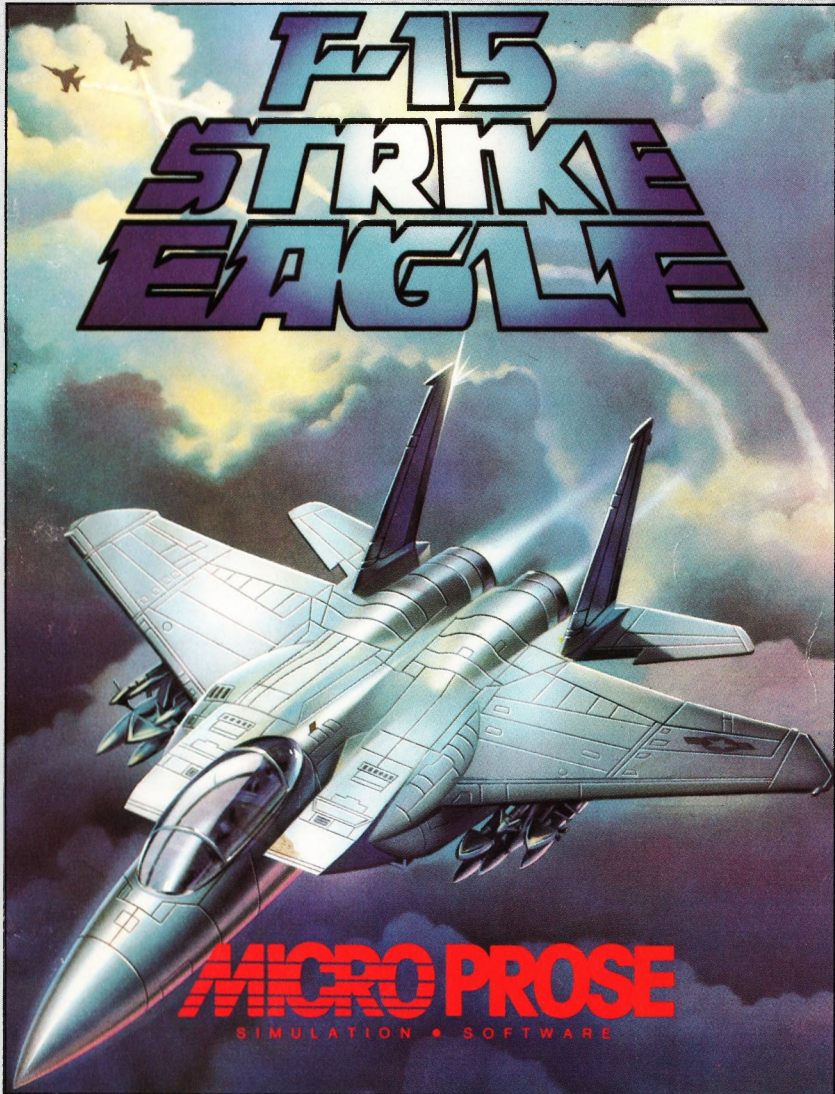

FLIGHT OPERATIONS MANUAL

...Dedicated to the men and women who build, maintain, and fly one of the world's greatest aircraft at McDonnell Douglas and in the U.S. Air Force. Remember the next time you hear a fighter jet go by — You are hearing the "Sound of Freedom."

Major Bill

FLIGHT OPERATIONS MANUAL

F-15 STRIKE EAGLE

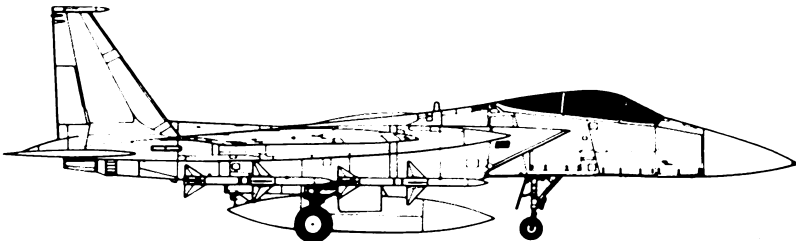



Dear Friend,

It is with great pleasure that I share with you some of the excitement and challenge of being a fighter pilot of today's modern aircraft with F-15 STRIKE EAGLE.

This program was designed by Sid Meier and myself to introduce you to the thrill of fighter aircraft flying based on my fourteen years experience. F-15 STRIKE EAGLE is a true simulation of what occurs in the pilot seat. It challenges you with many of the same decision processes, dangers, and mission requirements of real combat flying.

If there is anyway you feel it could be made more realistic or more entertaining, please drop me a note.

Have fun while learning to fly with me, the F-15 STRIKE EAGLE!

DANGER

Bill Stealey

Major BILL STEALEY,
Fighter Pilot
President,
MicroProse Software

F-15 STRIKE EAGLE

TABLE OF CONTENTS

I. PROGRAM MANUAL

- 1. Introduction**
- 2. Loading Instructions**
- 3. Computer Chart**
- 4. Options**
- 5. Authentication Codes**

II. F-15 FLIGHT MANUAL

- 1. Aircraft and Systems**
- 2. Flying the F-15**
- 3. Air Combat**
- 4. Missions**

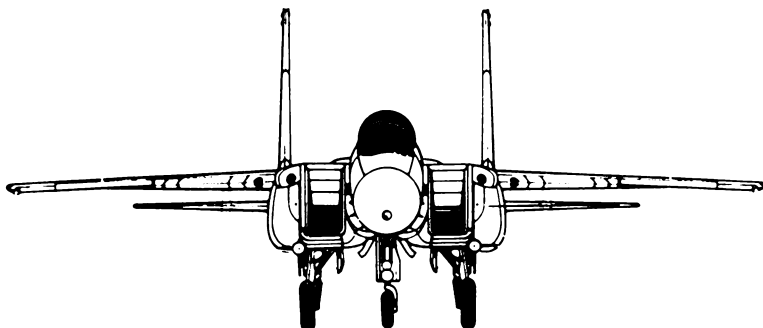

©Copyright 1985 by MicroProse Software.
120 Lakefront Drive, Hunt Valley, MD 21030
Original Software by Sid Meier,
Commodore 64 Version by Grant Irani.
Apple Version by Jim Synoski
Documentation Contributions by Paul Fudiccia

Commodore 64, ATARI, and APPLE are registered trademarks
of Commodore Business Machines Inc., Atari Inc.,
and Apple Computer Inc., respectively.

SECTION I PROGRAM MANUAL

1.0 INTRODUCTION

Air combat has advanced dramatically in speed, technological sophistication and complexity in a few short decades to the age of today's supersonic jet fighter. The modern fighter pilot must not only demonstrate the traditional combat flying skills, he must also master offensive and defensive weapons systems, energy management, navigation, and fuel conservation. Fortunately, the pilot is assisted by an impressive array of computer-controlled information displays. The "Heads-Up-Display" projects target and threat tracking information, navigational cues, and status messages directly onto the plane's windscreen. A graphic weapons status display provides instant, easy to read information as to the availability of missiles and bombs. A variable resolution radar, combined with radar and infra-red emission detectors displays the location of all active threats. A ground map and navigation cursor tells the pilot where he is and guides him to the selected target. But in spite of these sophisticated aids, the pilot is still the most important system in the aircraft; his ability in selecting the appropriate offensive weapons and defensive countermeasures, his judgement in selecting the optimal flight path to and from the target, his skill at piloting the plane in high speed aerial dogfights, and his courage in pressing on through concentrated enemy defenses remain the keys to success.

F-15 is a faithful simulation of the high-tech F-15 all weather air superiority and ground attack fighter, including all major flight, weapons, and information systems. F-15 also simulates the modern air combat environment with numerous enemy aircraft, radar guided missiles, infra-red missiles, air-air missiles, and ground targets. F-15 puts you in the cockpit of the world's most advanced fighter airplane to plan your strategy and make the critical split-second decisions which spell the difference between success or failure! Good Luck.

This Flight Manual provides a wealth of detail on the F-15, its flight and weapons systems, aircraft performance, and modern air combat tactics. You may wish to skip some of these sections and proceed as quickly as possible to flying the simulation. In this case, you should review the following sections:

SECTION I

- 2.0 LOADING THE SIMULATION
- 3.0 COMPUTER CHART
- 4.0 OPTIONS
- 5.0 AUTHENTICATION CODES

SECTION II

- 1.3 CONTROLS
 - 1.4 CONTROL STICK
 - 2.1.2 MISSION PROCEDURE
 - 4.0 MISSIONS
-

2.0 LOADING THE SIMULATION

2.1 COMMODORE 64

Note only one Joystick is used in the Commodore 64 version. The Joystick should be placed in joystick port #2 (nearest the back of the computer).

DISK: Place the program diskette in your disk drive. Type: **LOAD** *******, **8**, **1**. The program will boot automatically. Leave the disk in the drive.

CASSETTE: Place the program cassette in your program recorder (rewind if necessary). Press **RUN/STOP** while holding down the **"COMMODORE"** key. Press **PLAY** on the cassette recorder. Loading requires at least 10 minutes.

2.2 APPLE AND IBM VERSIONS

Note that only one joystick is used in these versions. (IBM versions may use keyboard only. See UFC keyboard.)

DISK: Place the program diskette in your disk drive and turn on your computer. The program will boot automatically. Leave the disk in the drive.

IBM Requires Color Card.

CASSETTE: Not available.

2.3 ATARI 400/800/1200/600XL/800XL

REQUIRES: 48K RAM, 1 or 2 joysticks.

REMOVE: All cartridges.

DISK: Place the program diskette in your disk drive and turn on your computer. The program will boot automatically. Leave the disk in the drive.

CASSETTE: Place the program cassette in your cassette recorder. (Rewind if necessary) Press **START** and power the computer on. Depress **PLAY** on the cassette recorder and hit the **RETURN** key. The program will load automatically and start after 6-8 minutes.

3.0 COMPUTER CHART

F-15 Strike Eagle is available for the Commodore 64, Apple, IBM and Atari computers. To accommodate the differences in keyboards, the following convention is used.

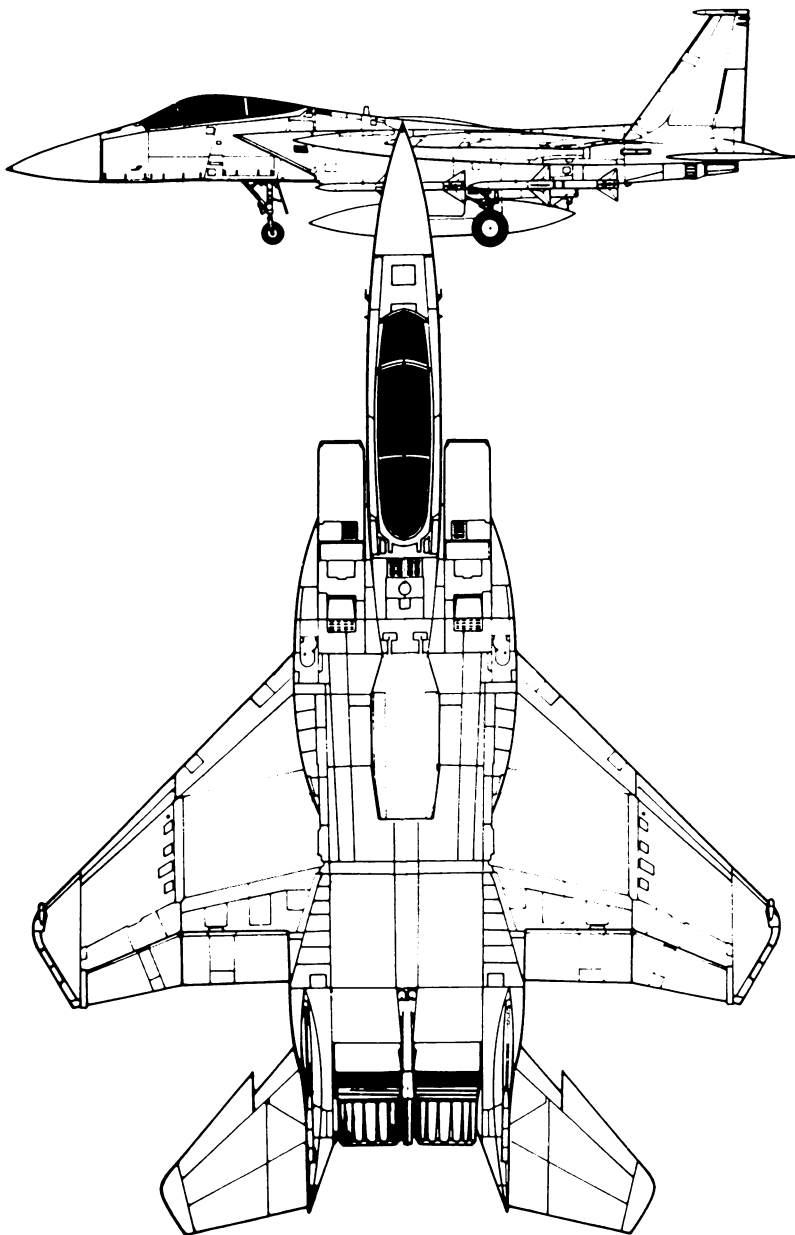

Documentation	C64	Apple	Atari	IBM
"OPTION"	"F1"	"1"	OPTION	"F2"
"SELECT"	"F3"	"2"	SELECT	"F1"
"START"	"F7"	CONTROL@*	START	ESC
Nav Cursor:				
Left	←	← or K	+	K
Right	→	→ or L	*	L
Up	↑	↑ or O	-	O
Down	↓	↓ or ,	=	;

*or button ∅ on joystick

4.0 OPTIONS

4.1 SKILL LEVEL

This simulation has four skill levels: **ARCADE**, **ROOKIE**, **PILOT**, and **ACE**. The ARCADE level does not faithfully simulate flight because the aircraft does not roll. It provides an introduction to the aircraft's systems for those with no prior flying experience.

As you progress from ROOKIE to ACE, it is more difficult to destroy both enemy aircraft and ground targets and there are more numerous and effective enemy aircraft and ground launched missiles that seek to destroy your aircraft. The skill level may be changed by use of the "OPTION" key.

4.2 MISSIONS

F-15 STRIKE EAGLE contains seven different missions. To select your initial mission, type a number from 1 to 7 (Apple: A-G). Your objective is to complete each mission by destroying the Primary Targets and returning successfully to your base. Once you have successfully completed your mission, you will fly the next mission, which is more challenging. You may return to your base before destroying all Primary Targets in order to refuel, repair damage, and reload weapons. In this case you will remain on the same mission until all Primary Targets are destroyed. (To Return to Base, (RTB), you must fly below 3000 feet over the base.)

4.3 NUMBER OF PLAYERS

Up to four players may participate. Use the "SELECT" key to choose the number of pilots. In multi-player games, each pilot's turn consists of one mission. Note that if a pilot returns to base without completing the mission or bails out and is rescued, the same pilot continues to play. The aircraft symbol after each pilot's score indicates which pilots are still active.

Two players may also play simultaneously, with one using the joystick to take the role of pilot and the other the role of weapons systems officer at the keyboard. (ATARI ONLY)

4.4 START

After option selection is completed, press "START" or the joystick trigger to begin the simulation.

5.0 AUTHENTICATION CODES

At the start of the simulation, you will be asked to enter your secret F-15 authentication code. It is important to enter the correct code in order to gain access to all flight and weapons systems. Consult the Authentication Code charts in this manual and type the countercode letter which matches the number displayed. (Example: if you have an Atari computer and the programs ask you to "Authenticate (1)", you type "A".) (On the Apple only, press **RETURN** after entering your code.)

6.0 SCORING

TOP SECRET

ALPHANUM	0	1
1	A	B
2	C	D
3	E	F
4	G	H
5	I	J
6	K	L
7	M	N
8	O	P
9	Q	R
0	S	T

LEVEL	ARCADE	ROOKIE	PILOT	ACE
PRIMARY TARGETS	500	1000	1500	2000
AIR TARGETS	150	300	450	600
GROUND TARGETS	200	400	600	800

IMPORTANT: If you don't enter the proper code response, you will not be able to launch missiles or drop bombs!!

SECTION II

F-15 STRIKE EAGLE FLIGHT MANUAL

1.0 AIRCRAFT AND SYSTEMS

1.1. F-15 STRIKE EAGLE SPECIFICATIONS

1.1.1. GENERAL

TYPE: Single-seat, all-weather, air superiority and ground attack fighter.

DIMENSIONS: Wing span 42 feet; length 63 feet; height 18 feet.

ENGINES: Two Pratt & Whitney F100-PW-100 turbofans each rated at 14,375 pounds thrust unaugmented, 23,930 pounds with afterburner.

FUEL CAPACITY: 13,455 pounds internal, 11,895 pounds in external drop tanks.

1.1.2. PERFORMANCE

MAXIMUM LEVEL SPEED: 1440 knots at 36,000 feet, Mach 2.5+; 800 knots at sea level, Mach 1.2.

STALL SPEED, LEVEL FLIGHT: 100 knots.

INITIAL CLIMB RATE: Over 50,000 feet per minute.

SERVICE CEILING: 62,000 feet.

COMBAT RADIUS: 1000 miles.

DESIGN G LIMITS: +7.33/-3.0.

FUEL CONSUMPTION: 0.7 pounds of fuel per hour per pound of thrust.

1.1.3. TARGET/THREAT DETECTION

RADAR: Hughes APG-63 X-band pulse-doppler, providing long range detection and tracking of targets at all altitudes.

WEAPONS CONTROL: Radar data and weapons status processed by computer and displayed on a Heads-Up-Display (**HUD**) and other displays.

TACTICAL ELECTRONIC WARFARE SYSTEM (TEWS): Radar Warning Receiver (**RWR**), Infra-red Warning Receiver (**IRWR**), Westinghouse ALQ-119 (V) active radar jammer, chaff dispenser, flares.

1.1.4. ARMAMENT

GUN: M-61A1 six-barrel 20mm rotary cannon firing 6000 rounds per minute; 1000 rounds of ammunition.

MISSILES: AIM-9L Sidewinders (four). Short range (effective range 1000 feet to 10 miles), Mach 3.0, all-aspect (able to home on airframe heat from any angle) passive infra-red (heatseeking). AIM-7F Sparrows

(four). Medium range (maximum range 62 miles, optimum range 30 miles), Mach 4.0, all-weather, semi-active radar homing.

BOMBS: Six groups of three bombs each (18 bombs), 500 pound, MK-82 low-drag, general purpose.

1.2 F-15 STRIKE EAGLE COCKPIT DISPLAYS

The F-15 STRIKE EAGLE cockpit is a complex and stressful working environment. Aircraft designers make special efforts to help reduce the load on the pilot to make him more effective in combat and improve his chances for survival. This simulation provides you many of the same devices provided the real F-15 pilot. (See center illustration)

1.2.1. FORWARD AND REAR VIEW

You may select the view rearward by pressing the space bar, and return to the view forward by pressing the space bar again. The forward view includes the HEADS-UP-DISPLAY and the instrument panel. The rear view is only of the sky, the ground or sea surface, and any other aircraft or missiles. When over ground, the surface is green; when over water it is blue.

1.2.2. HEADS-UP-DISPLAY (HUD)

The following essential flight and aircraft systems information is projected on a glass plate in the pilot's forward line of sight directly above the instrument panel.

AIRSPEED: "SPD:600" indicates that you are flying at 600 knots. A knot is one nautical mile per hour (100 knots equals approximately 115 miles per hour).

ALTITUDE: "ALT:9000" indicates that you are flying 9000 feet above the ground.

AIRCRAFT LINE OF FLIGHT: A circle containing an AIRCRAFT SYMBOL is in the center of the HUD. It displays the line of flight of your aircraft. Your guns will shoot to the aircraft's line of flight and the cannon shells will converge on the AIRCRAFT SYMBOL.

AIR-TO-AIR RETICLE: The stationary reticle surrounding the AIRCRAFT SYMBOL is used for aiming the guns and missiles. For the highest probability of hits with the guns, get directly behind the enemy aircraft with his wing span filling the aiming circle. If the enemy aircraft is flying at an angle to your line of flight, you must lead the enemy aircraft by aiming in front of it to allow for your weapons time of flight: for a 45 degree deflection shot, lead by one aiming circle radius; for a 90 degree deflection shot, lead by two aiming circle radii.

AIR-TO-GROUND RETICLE and LINE OF IMPACT: The smaller flashing/moving reticle that appears when you are in the BOMB mode indicates the projected impact point of the bombs. The line that connects the AIR-TO-GROUND RETICLE to the AIRCRAFT SYMBOL is the LINE OF IMPACT. It displays the line along which the bombs could impact by changing the pitch of the aircraft. By placing the target on the LINE OF IMPACT by turning, you can roll level and then place the AIR-TO-GROUND RETICLE on the target by pitching up or down.

PITCH LINES: The horizontal lines indicate how many degrees your aircraft is pitched up or down. When the horizon is on the longest pitch line, the one that is level with the aircraft symbol, you are in level flight. Each pitch line represents 10 degrees. When you are diving to line-up with a ground target, you should be in a 30 degree dive, and the horizon should be on the third line above the aircraft symbol.

TARGET DESIGNATOR BOX: The TARGET DESIGNATOR BOX indicates the position of an enemy aircraft that has been detected by the search and tracking radar or by your radar or infra-red warning receiver. The TARGET DESIGNATOR BOX aids you in planning and positioning yourself for an attack before the target is within visual range. When the enemy aircraft is within visual range, it will appear inside this box. When you have selected either the MEDIUM RANGE MISSILE or the SHORT RANGE MISSILE mode, the letter "M" will appear in the TARGET DESIGNATOR BOX to show that a missile is armed.

MISSILE DESIGNATOR BOX: The MISSILE DESIGNATOR BOX indicates the position of air or ground launched missiles. It aids you in evading missiles launched against you which are small and therefore difficult to see.

STEERING CUE: The flashing letters "NAV" indicates the direction of flight corresponding to the location of the NAVIGATION CURSOR on the HORIZONTAL SITUATION DISPLAY. By flying to this indicator, you will fly toward the area on the map under the NAVIGATION CURSOR.

1.2.3. MESSAGES

In addition to the information that is always displayed in the HUD, the following messages may be flashed in the lower left corner of the HUD:

WEAPONS SYSTEM MODES:

"**GUN 900**" indicates that you are in the GUN mode and that you have 900 rounds remaining. In the GUN mode, when you press the trigger on the control stick, you fire a burst of 25 shells.

"**MISSILE ARMED**" indicates that you have armed either a SHORT RANGE MISSILE or a MEDIUM RANGE MISSILE. In a missile mode, when you press the trigger on the control stick, you fire the type of missile that you armed.

"BOMB ARMED" indicates that you have armed a "stick" of three 500 pound bombs. In the BOMB mode, when you press the trigger on the control stick, you release the "stick".

WEAPONS RESULTS:

"ENEMY PLANE HIT" indicates that you have achieved a lethal hit by cannon shells or missiles on an enemy aircraft.

"BOMBS RELEASED" indicates that the stick of bombs has been released and that you may pull up or take evasive action.

"BOMBS MISS" indicates that you have missed your ground target.

"TARGET HIT" indicates that you have destroyed the ground target.

WARNINGS:

"ALERT: SAM LAUNCH" indicates that a surface-to-air missile (SAM) has been launched against your aircraft.

"DAMAGE WARNING" indicates that your aircraft has been damaged by a missile.

"ALERT: AIR MISSILE" indicates that an air-to-air heatseeking missile has been launched against your aircraft.

DEFENSIVE SYSTEMS:

"LONG, MEDIUM, SHORT RANGE RADAR" indicates what scale your RADAR-ELECTRONIC WARNING DISPLAY is on. The short range scale displays an area of 400 square miles (10 miles in each direction from the aircraft), the long range scale displays an area of 1600 square miles (40 miles in each direction).

"ECM JAMMING" indicates that your electronic countermeasure active radar jamming device is operating and that you have released "chaff" to decoy ground launched radar homing missiles.

"FLARE RELEASED" indicates that you have released a flare to decoy heatseeking missiles.

1.2.4. MAXIMUM SPEED

TOP SECRET

Atari/Apple	2	3
C-64	H	P
Apple	2	3
Apple	1	2

If the aircraft is approaching the maximum "red line" speed, the top of the HUD (Atari) or the screen border (C-64) or the sides of the radar screen (Apple) flash red to warn you to immediately reduce your air-speed by pulling back on the throttle, extend your speedbrakes, pull up, or any combination to reduce your speed and prevent pulling the wings off your aircraft at Vmax.

1.2.5. INSTRUMENT PANEL

Additional information is displayed on the aircraft's instrument panel.

MACH NUMBER: "Mach: .9" indicates that you are flying at .9 (90%) of the speed of sound (661 knots at sea level, decreasing with altitude). Note that the decimal point is not displayed.

HEADING: "HDG:180" indicates that you are flying on a heading of 180 degrees (south).

ENGINE POWER: "RPM: 90" indicates that your engines are at 90 percent of maximum RPM. "AFT" indicates that your afterburners are engaged, giving you approximately 60 percent more thrust than at 100 percent RPM.

FUEL REMAINING: "FUEL: 20000 LBS" indicates that you have 20,000 pounds of fuel remaining (one gallon of jet fuel weighs approximately six pounds). Fuel capacity is 13,500 pounds in on board tanks and 10,000 in external tanks. Fuel consumption depends on engine power, with afterburners consuming fuel at about a 60 percent higher rate than at the 100% RPM level.

WARNING INDICATORS: There are four warning indicator lights: the first indicates that you are being tracked by radar and the target of a radar homing missile; the second indicates that your infra-red warning system has detected an intense heat source such as that produced by a missile; the third indicates that you are at a low altitude (below 6100 feet); and the fourth indicates that your fuel remaining is low (less than 5000 pounds) and you should begin to return to base.

1.2.6. WARNING HORNS

In addition to visual information, there are two warning horns which indicate impending contact with the ground (based on altitude and rate of descent) PULL UP IMMEDIATELY!; or approach to stall speed (based on airspeed and bank angle) apply more power.

1.2.7. HORIZONTAL SITUATION DISPLAY (HSD)

The **HSD** displays a map of the area over which the mission is to be flown. It depicts the primary target or targets, secondary targets, which are airfields and surface-to-air missile sites, your base, and geographic features such as rivers and coast lines.

Your aircraft's position and direction of flight are indicated by the position and orientation of the flashing aircraft symbol.

The **NAVIGATION CURSOR** is tied into your aircraft's inertial navigation system and can greatly reduce the workload on the pilot. Simply pick the location you want to fly to; use the computer cursor control keys (see the computer chart) to move the cursor square over your desired target; bank the aircraft to put the nose of the aircraft pointed directly at the flashing "N", "A", "V" letters projected on the HUD; the aircraft will now fly directly to your desired target. Great for locating a target or returning to base.

1.2.8. RADAR-ELECTRONIC WARFARE DISPLAY (REWD)

The **REWD** displays targets in the airspace and on the ground surrounding your aircraft. You can change the scale by pressing the “**R**” key. Each grid line represents 10 miles. Your aircraft is always in the center of the display pointing up. The REWD displays the returns from your radar, from your Radar Warning Receiver (**RWR**, which alerts you that a ground-based or airborne radar is tracking your aircraft), and from your Infra-red Warning Receiver (**IRWR**, which alerts you that a surface-to-air or an air-to-air missile has been launched) is also displayed.

The position and direction of enemy aircraft are shown. They are displayed if they are detected by your search and tracking radar, by your Radar Warning Receiver (**RWR**) which detects other aircraft’s radar emissions, or by your Infra-red Warning Receiver (**IWR**) which detects the heat of other aircraft’s engines. Primary ground targets are depicted as well as airports, surface-to-air missile (**SAM**) sites, and your base.

1.2.9. WEAPONS STATUS DISPLAY (WSD)

The **WSD** provides the combat pilot with a quick visual reference of his available weapons stores. It displays all remaining three bomb “sticks” of bombs, medium range missiles, short range missiles, flares, and the status of the fuel drop tanks.

1.3. CONTROLS

TOP SECRET

SEARCH	1	2
MODE	3	4
MODE	5	6
MODE	7	8
MODE	9	0

1.3.1. UP FRONT CONTROL (UFC)

The **UFC** is immediately below the HUD in the F-15. In this simulation it is your keyboard. You select weapons modes, control the radar, activate defensive systems, and operate all controls necessary for combat that are not operated by the CONTROL STICK and THROTTLE. It is also a backup for the controls activated by the THROTTLE if joystick 2 is not used. The UFC’s functions are as follows:

ACTIVATE GUN MODE: Press “**G**” to arm the guns. When within 1000 feet of your target, press the trigger on the CONTROL STICK to fire a burst of 25 cannon shells. Gun mode is automatically selected at the beginning of the simulation and whenever no bombs/missiles are armed.

ACTIVATE SHORT RANGE MISSILE MODE: Press “**S**” to arm a short range, heatseeking Sidewinder missile and lock its seeker head into the AIR-TO-AIR RETICLE on the HUD. Press the trigger on the CONTROL

STICK to launch the missile when the target is between one half mile and ten miles away and is within the reticle. You may not launch a missile until the previous missile has completed its flight.

ACTIVATE MEDIUM RANGE MISSILE MODE: Press “M” to arm a medium range, radar homing Sparrow missile and lock its homing device into the AIR-TO-AIR RETICLE on the HUD. Press the trigger on the CONTROL STICK to launch when target is between 10 and 40 miles away.

ACTIVATE BOMB MODE: Press “B” to arm a stick of three 500 pound bombs and activate the AIR-TO-GROUND RETICLE on the HUD. Press the trigger to release the “stick” when the BOMB AIMING RETICLE is inside the target triangle. You should be in a 30 to 40 degree dive for best results. Release at 2000 feet and pull up immediately.

THROTTLE: Press numbers “0” (55%) through “9” (100% RPM) for aircraft power and adjustment.

AFTERBURNER: Press “A” to engage. Any throttle command will cancel. The afterburner increases thrust (and fuel consumption) by 60 percent over the unaugmented thrust at 100 percent throttle.

SPEEDBRAKE: Press “X” to extend. Any throttle command will retract. The speedbrake reduces your aircraft’s speed to approximately 75 percent of whatever speed it would have with the speed brake retracted.

DEFENSE AGAINST RADAR HOMING MISSILES: Press “E” to activate the electronic countermeasures radar jammer and to release chaff to decoy a radar homing missile. Electronic countermeasures are effective for a short period of time. They also become less effective each time they are used.

DEFENSE AGAINST HEATSEEKING MISSILE: Press “F” to release a flare. The heat of the flare will decoy a heatseeking missile away from your aircraft. If the heatseeking missile is within range it may explode on the flare. Flares burn for 5-10 seconds.

DROP EXTERNAL FUEL TANKS: Press “D” to drop your external fuel tanks when empty (when fuel remaining is less than 13,500 pounds) for extra speed and range.

NAVIGATION CURSOR: Press **cursor control keys** (see Computer Chart) to move the cursor.

FRONT OR REAR VIEW: Press the **space bar** to change from front to rear view and back again.

BAIL OUT: Press **Esc (C64: “ ← ”, IBM: “TAB”)** to eject. You may be rescued and go on to fly other missions or be captured and end the simulation.

RADAR RANGE: Press “R” to change the range scale of the RADAR-ELECTRONIC WARFARE DISPLAY. (Note: Joystick must be centered prior to pressing “R” on C-64 or bailout may result.)

PAUSE: Press “P” to pause the simulation. Press any other key to resume.

START: Pressing “START” during the game will abandon the current game and return you to the initial selection screen.

1.4. CONTROL STICK

1.4.1. Joystick 1 is the CONTROL STICK

It is used to control the altitude of the aircraft and to activate the weapons — to fire the gun, launch missiles, or drop bombs.

Moving the control stick left or right causes the aircraft to bank and begin a turn in that direction. Left and right movement is used to maintain wings level flight and to establish the required bank angle for turning. Moving the Control Stick forward or back changes the pitch (nose up or nose down) of the aircraft. This generally results in a climb or descent with corresponding airspeed changes. See section 2.1 on Basic Flying for a more detailed discussion of Control Stick movements and effects. The trigger on the Control Stick is the fire button. Pressing the trigger will fire the gun, launch an air-to-air missile, or drop a stick of bombs.

Pushing the stick forward pushes the nose of the aircraft down, (unless the aircraft is inverted, in which case it pushes the nose up.) Pushing the nose down will cause the aircraft to dive, the altitude to decrease and the airspeed to increase (unless engine power is decreased or the speedbrake is extended). CAUTION: If the airspeed is allowed to climb to the maximum speed for your altitude, your aircraft may suffer structural failure (usually the separation of a wing or stabilizer). The speed brake can be used to rapidly reduce speed and should be used for steep dives.

1.4.2. THROTTLE

TOP SECRET

0	1	2	3	4	5	6	7
C	SA	M	M	M	M	M	M
0	1	2	3	4	5	6	7
0	1	2	3	4	5	6	7

The keyboard keys 1-9, and 0 are used as the F-15 THROTTLE. "0" (zero) is idle thrust. "A" activates the afterburners. Moving the THROTTLE forward increases the engine RPM in 10 percent increments; moving it back decreases the engine RPM in 10 percent increments. (Atari only - Joystick 2 can be used as the throttle. It controls engine RPM, the afterburner, the speedbrake, and the weapons mode. Moving it to the left activates the afterburner; moving it forward or backward deactivates the afterburner. Moving it to the right extends the speedbrake; moving it forward or backward retracts the speedbrake. Pressing the trigger on the THROTTLE changes the weapons mode, from GUN to SHORT RANGE MISSILE to MEDIUM RANGE MISSILE to BOMB and then back to GUN. Note that all Joystick 2 functions may be performed using the keyboard.)

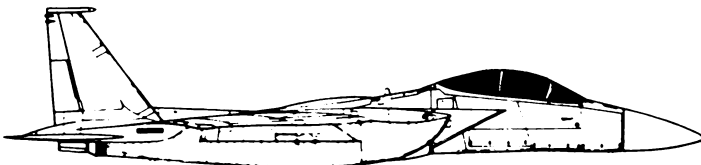

2.0 FLYING THE F-15

2.1 AIRCRAFT CONTROL

Moving the stick forward or rearward changes the pitch (up or down) attitude of the aircraft. Pulling back on the stick pulls the nose of the aircraft up (unless the aircraft is inverted, in which case it pulls the nose down). Pulling the nose up will cause the aircraft to climb, the altitude to increase and the airspeed to decrease (unless engine power is increased). If the airspeed is allowed to fall to the stall speed (100 knots in level flight at sea level), the aircraft will stall. Therefore, you must add engine power when climbing to maintain airspeed and to avoid a stall if the climb is steep and sustained.

Moving the stick to the right or left controls the roll motion of the aircraft and thus the aircraft's bank angle. For example: a right turn would be accomplished as follows. 1) Move the stick to the right to roll right. 2) Neutralize the stick when the bank angle is achieved for the desired rate of turn (the steeper the bank angle the higher the rate of turn, a 45 degree bank is a normal bank angle). 3) Add throttle to maintain airspeed (because of the extra drag created by turning) and be careful not to stall (stall speed is higher in a turn than in level flight because of the higher "G" loading on the aircraft). (See section 2.3 for an explanation of the aerodynamics of a turn.) 4) When you are near the desired heading, roll to the left until you are level and reduce throttle.

In an aircraft it is necessary to coordinate your ailerons (the control surfaces in the wings that control bank angle) with your rudders (the control surfaces in the vertical stabilizers that control yaw — the right and left movements) and your elevators (the control surfaces in the tail that control pitch attitude). The F-15 simulator automatically interconnects these control surface movements to apply the correct amount of up elevator to keep the nose from dropping. This permits turns of any bank angle without the need to pull the stick back to maintain altitude. Pulling the stick back will raise the nose in a shallow bank and increase the turn rate in a steep bank.

2.1.2. MISSION PROCEDURE

Once you have the basics of turning, climbing, diving, and level flight, you are now ready for your first real combat mission. As each mission begins, you are flying at a medium altitude and a high cruise airspeed appropriate for combat engagement. When cruising toward a target, use Cruise Power, 90 percent RPM, to conserve fuel while retaining sufficient speed to respond to threats.

You should first plan your mission flight path. Use the Horizontal Situation Display to identify your current position and the location of your primary target(s). Select a flight path to and from the target. You may wish to avoid major SAM and Airport concentrations, or you may

select an aggressive flight plan and knock out some of these installations. You may also decide on a high-altitude penetration to minimize the effectiveness of SAM missiles, a medium altitude penetration to save time, or a low altitude penetration to neutralize radar-guided missiles. For the more difficult missions you might select a multiple flight strategy and return to your base to re-fuel and re-arm as necessary.

When you have determined your flight plan, place your NAVIGATION CURSOR on the first objective. The STEERING CUE will guide you to your target. You might climb to 36,000 feet for best speed and range. Higher altitudes can be used to evade surface-to-air missiles or less capable enemy aircraft. Or, to avoid surface-to-air missile (SAM) radars, stay below 1500 feet. However, note that at these low altitudes turbulence affects your altitude. Don't fly into the ground!

On your way to the target you will need to defend yourself against heatseeking missiles, radar-guided missiles, and enemy aircraft. Each of these threats has different flight characteristics and must be dealt with by appropriate countermeasures. The first requirement is to identify threats as soon as possible. All missile launches will be reported by a HUD message. Locate the missile on the Long Range Radar scan. Use the radar and infra-red warning indicators to identify the missile as radar-guided or heatseeking. (All air-launched missiles are heat-seeking; ground-launched missiles may be either heatseeking or radar-guided.) Enemy aircraft may be identified via the Long Range Radar or by the appearance of the Target Designator Box.

There are a number of countermeasures available to decoy heat-seeking missiles. You may turn toward the missile (to present your cold side to the heatseeker). If this is not effective you may release a flare to fool the heatseeker into attacking the flare instead of you. Your IR warning light will indicate the effectiveness of your countermeasure. As a last resort you may punch up the Short Range Radar Display and try to out-fly the missile. Remember that the missile is faster than your plane but you may be able to out-turn the missile in a high-G turn.

If a radar homing missile is approaching your aircraft, press "E" to activate your radar jammer and to release chaff (radar reflective material) to fool the radar homing missile into attacking the chaff instead of you. Activate your countermeasures when the missile is about three to five miles away, then take evasive action.

The best defense against enemy aircraft is to destroy them before they come close enough to be a threat. Use a medium range missile for targets more than 10 miles away. Since the guidance system on the **MRM** requires about 10 seconds to acquire the target, you should fire your missile towards the Target Designator Box. For targets at ranges of less than 10 miles, use a Short Range Missile. An **SRM** locks on to the target immediately and does not require careful aiming. (You may even fire an SRM at a target behind you with a reasonable hit probability!)

UP FRONT CONTROL (UFC) KEYBOARD

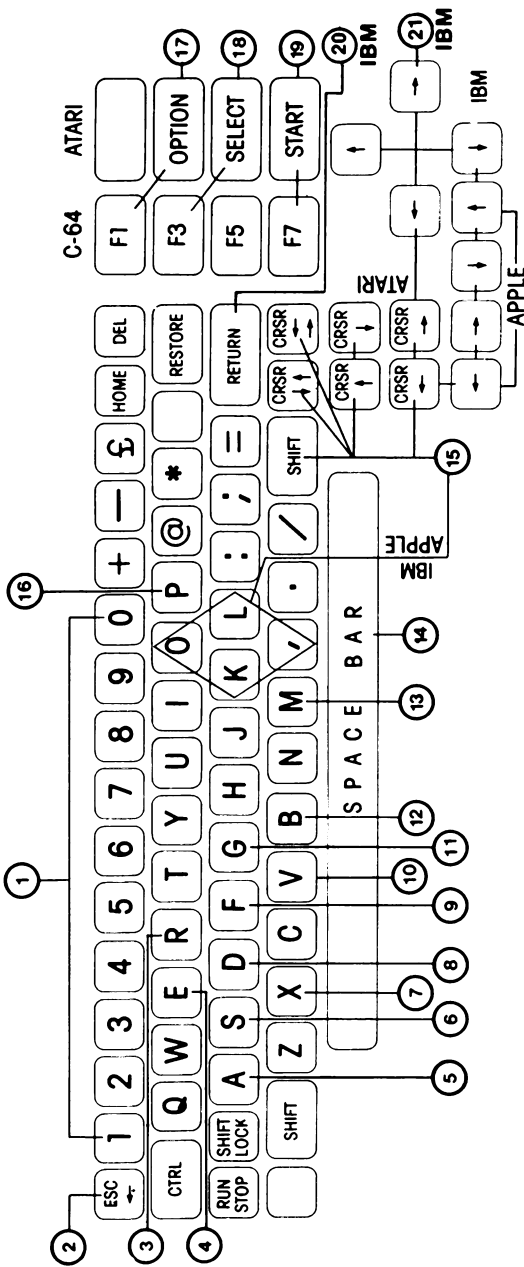

- | | | | |
|---------------------------------|---|-------------------------------------|--|
| 1. BACKUP THROTTLE | 6. SHORT RANGE MISSILE ARM SWITCH | 12. BOMB ACTIVATE SWITCH | 18. NUMBER OF PLAYERS |
| 2. BAILOUT SWITCH | 7. SPEED BREAK SWITCH | 13. MEDIUM RANGE MISSILE ARM SWITCH | 19. START/RESTART SWITCH |
| 3. RADAR RANGE SELECTOR | 8. DROP TANK RELEASE | 14. FRONT/REAR VIEW CONTROL | 20. ALTERNATE FIRE BUTTON (IBM KEYBOARD) |
| 4. MEASURES AND CHAFF DISPENSER | 9. FLARE ACTIVATE SWITCH | 15. NAVIGATIONAL TARGETING CURSORS | 21. ALTERNATE CONTROL STICK (IBM KEYBOARD) |
| 5. AFTERBURNER IGNITOR SWITCH | 10. IBM SOUND EFFECT TOGGLE (3 positions) | 16. PAUSE CONTROL | |
| | 11. GUN ACTIVATE SWITCH | 17. SKILL LEVEL | |

F-15 STRIKE EAGLE

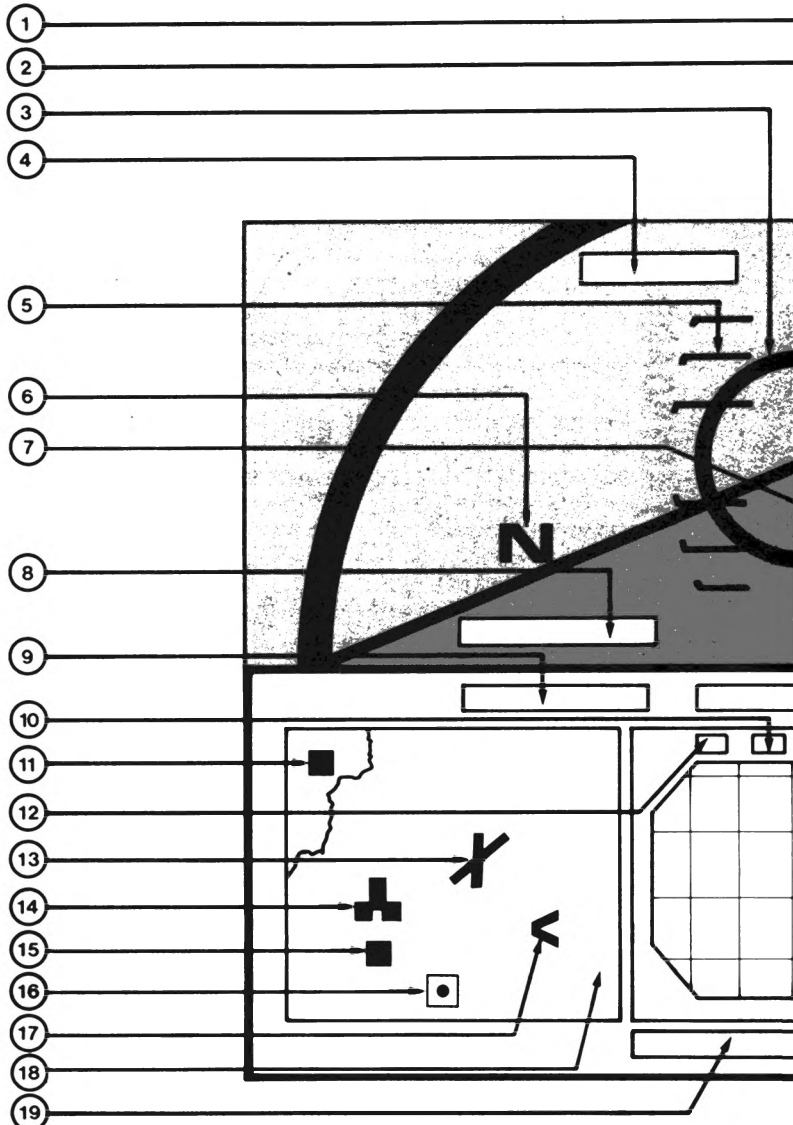

1. HUD ALTIMETER
2. HUD HEADING
3. AIR TO AIR RETICLE
4. HUD AIRSPEED
5. PITCH LINES
6. STEERING CUE
7. AIR TO GROUND RETICLE

8. MESSAGE INDICATOR
9. MACH INDICATOR
10. INFRA-RED WARNING INDICATOR
11. F-15 BASE
12. RADAR WARNING INDICATOR
13. AIRFIELD
14. SAM MISSILE SITE

15. NAVIGATION CURSOR
16. PRIMARY TARGET
17. AIRCRAFT POSITION INDICATOR
18. HORIZONTAL SITUATION DISPLAY (HSD)
19. FUEL STATUS DISPLAY
20. AIR TARGET DESIGNATOR BOX

COCKPIT LAYOUT

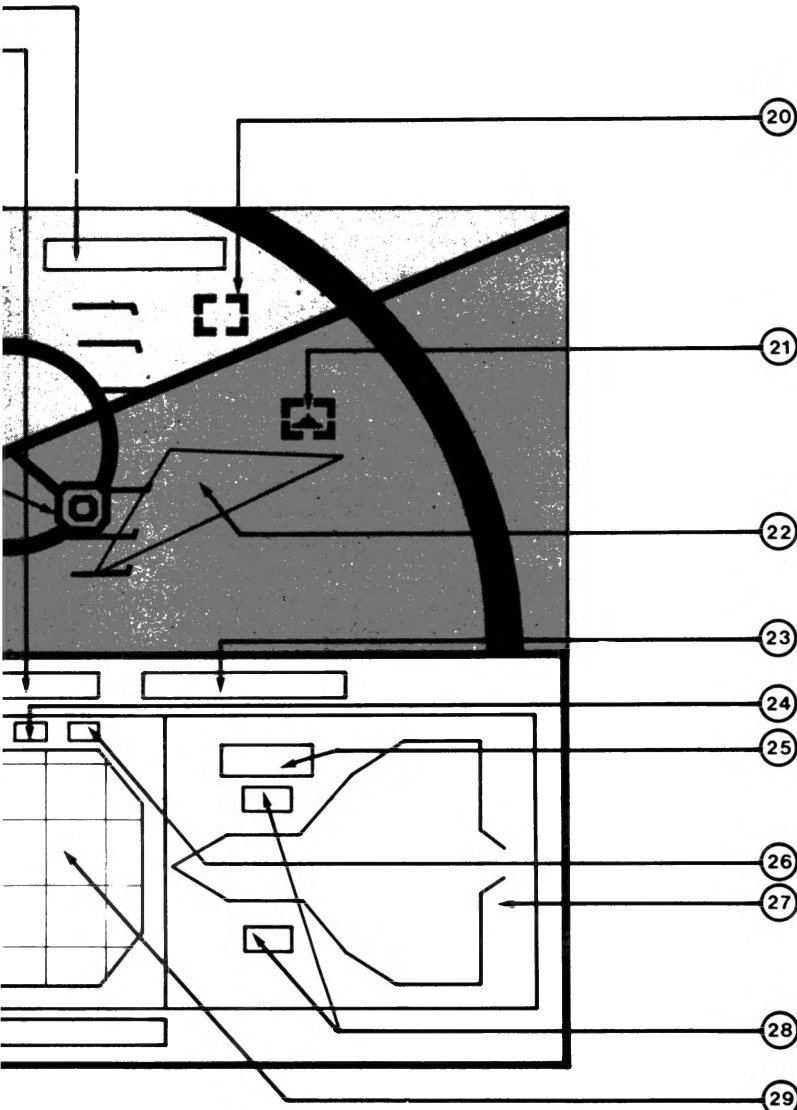

- 21. MISSILE DESIGNATOR BOX
- 22. GROUND TARGET
- 23. ENGINE POWER INDICATOR
- 24. LOW ALTITUDE WARNING
- 25. WEAPONS ARMED INDICATOR
- 26. FUEL LOW WARNING
- 27. WEAPONS STATUS DISPLAY (WSD)
- 28. DROP TANK INDICATOR
- 29. RADAR-ELECTRONIC WARFARE DISPLAY (REWd)

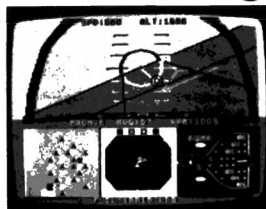

ATARI SCREEN PICTURE

**CONTROL STICK
(FLIGHT CONTROLS)
JOYSTICK # 1**

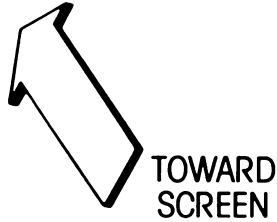
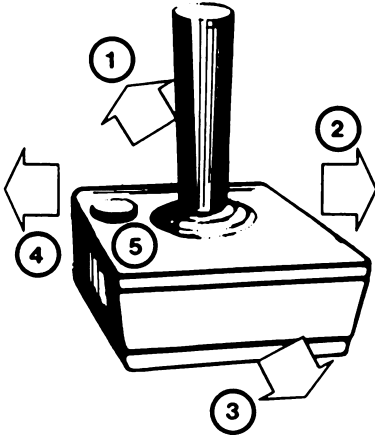

**THROTTLE
(OPTIONAL)
JOYSTICK # 2**

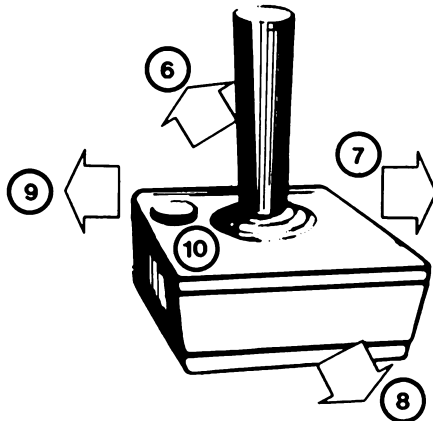

- 1. NOSE DOWN
- 2. BANK RIGHT
- 3. NOSE UP
- 4. BANK LEFT
- 5. WEAPONS TRIGGER
- 6. INCREASE THROTTLE

- 7. SPEED BRAKES EXTEND
- 8. DECREASE THROTTLE
- 9. AFTER BURNERS ON SWITCH
- 10. WEAPONS SELECTOR SWITCH

For close range visual targets, use your cannon. Note that you must lead the enemy aircraft to obtain a hit. Although one missile hit will destroy an enemy aircraft, a couple of gun hits are generally required.

Keep your radar on long range scan unless you are already engaged and need an uncluttered look at your immediate vicinity. The long range radar will give you the most warning of threats and ground targets.

Use a 45 degree bank angle for most turns. Establish your desired heading before climbing steeply because you may lose sight of the horizon. Use pitch angles of 30 degrees or less to avoid major airspeed changes.

Use a 70-90 degree bank for high turn rate combat maneuvering, pull back on the stick in a 90 degree bank for the maximum turn rate. Use the afterburner to maintain airspeed for a sustained high rate turn.

To maximize your probability of a bomb hit, line up for a straight-in run using the Navigational Cursor and your Long Range Radar. Make your bombing pass at moderate speed and less than 5000 feet. When the target triangle appears, begin a shallow dive. As the triangle grows, maneuver to place your air-to-ground reticle in the middle of the triangle. Press the trigger (be sure your bombs are armed). Of course a slow, straight bombing pass leaves you a sitting duck for SAM missiles and enemy aircraft.

If you do get into trouble and your plane is damaged, your best bet is to try to return to base for repairs. If this is not possible, bail out; you have a 50/50 chance of being rescued.

Section 3.0 (Air Combat) provides more detail on combat tactics and techniques. Good planning, skillful flying, and the proper use of all of the F-15's sophisticated systems is the key to a successful mission. This simulation accurately rewards the pilot who masters these skills.

2.2 BASIC AERODYNAMICS

There are four forces acting on an aircraft in flight: lift, weight, thrust, and drag.

Lift increases with: 1) increased angle of attack (the angle between the wing and the aircraft's flight path) up to the maximum angle of which the wing is capable without stalling; 2) increased air density (air is denser at lower altitude); and 3) the square of an increase in airspeed (at twice the airspeed a wing will produce four times as much lift). Weight decreases as fuel is burned and as missiles and bombs are released.

At constant throttle, thrust increases with increased airspeed (because of the ram effect of high speed air entering the engine, raising its pressure even before it enters the engine's compressor) and decreases with increased altitude (because the air is less dense). Drag increases with the square of an increase in airspeed (form drag, created by the aircraft's cross section forcing its way through the air and by skin friction) and with increased angle of attack (induced drag, created by

the pressure differential between the low pressure air above the wing and the high pressure air below the wing that generates lift); drag decreases with increased altitude (because the less dense air offers less resistance).

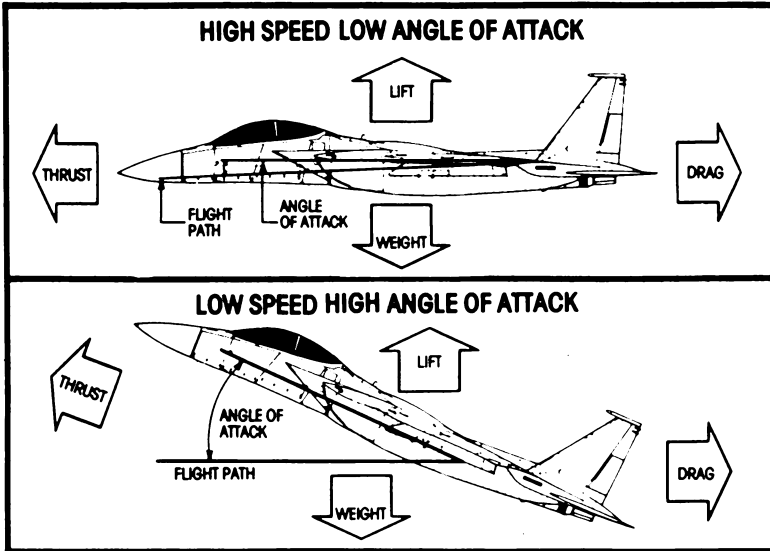

When lift equals weight and thrust equals drag, the aircraft's altitude and airspeed will remain constant — the aircraft is in equilibrium. If lift is increased or weight reduced, the aircraft will climb; if lift is reduced it will descend. If thrust is increased, the airspeed will increase; if thrust is decreased or drag increased, the airspeed will decrease.

Lift acts perpendicular to the wing; weight acts vertically, straight down. When an aircraft banks in order to turn, lift acts at an angle to the vertical.

In a bank, part of the lift acts to the side, providing the turning force, and the rest of the lift acts vertically, to oppose the aircraft's weight. To maintain altitude in a turn, the vertical component of lift must equal the aircraft's weight. Since part of the lift is acting to the side, the total lift must exceed that required for level flight. At steep bank angles, total lift must be several times larger than in level flight for the vertical component of lift to oppose the aircraft's weight. (At 60 degrees of bank, 2G's or twice the normal lift is required to hold level flight).

In a turn, lift is increased by increasing the angle of attack. This is done by pulling back on the stick. In a sustained turn, the pilot can remove the stick force necessary to maintain the proper angle of attack by "trimming" the controls to provide the necessary back pressure on the stick. In this simulation, the appropriate trim is automatically applied,

relieving you of the need to apply back pressure in a turn to maintain altitude. In a shallow bank, pulling back on the stick will primarily cause the nose to pitch up; in a steep bank, it will primarily increase the turn rate.

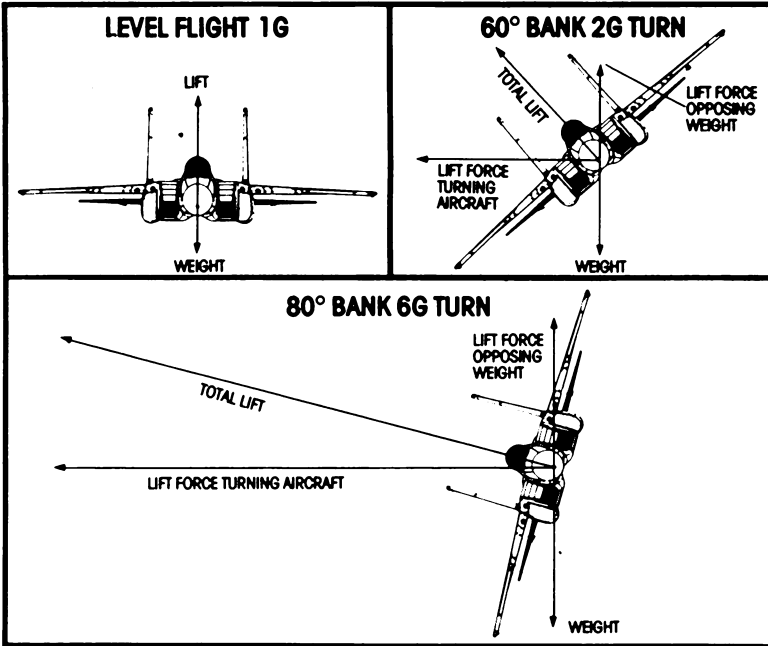

Increasing the angle of attack increases drag, increases the G force on the aircraft (as the total lift increases above the amount necessary to oppose and thus support the aircraft's weight in level flight, 1 G), and increases stall speed (the minimum speed at which the wing generates significant lift) by the square root of the G force (stall speed is doubled in a 4G turn). To avoid stalling and spinning out of control in a steep bank, you must maintain an airspeed above the stall speed for your bank angle and altitude (stall speed increases with increased altitude because the less dense air has less lifting capacity). In steep turns, full throttle or even afterburner may be required to maintain altitude without stalling.

2.3. TURNING PERFORMANCE

One of the most important performance attributes of a fighter aircraft is its rate of turn. A rate of turn higher than that of your opponent enables you to turn with and lead your opponent for a gun or missile attack and to prevent him from leading you if he is behind you in a turn. You lead a target by aiming in front of it so that your bullets or missile and the target arrive at the same point in space at the same time.

An aircraft's turn rate increases with bank angle (and therefore with G force) and decreases with altitude (because the less dense air has less capacity to produce the high lift needed to steep banking turns). At low altitude in a steep turn, the turn rate increases as airspeed increases from stall speed to approximately Mach 0.8, then it decreases sharply. At higher altitudes, the maximum turn rate is less, is reached at a higher speed, and does not decrease as sharply with increased speed. Best turning performance is always below Mach 1.0, and generally is in the Mach 0.8, 500 knot range.

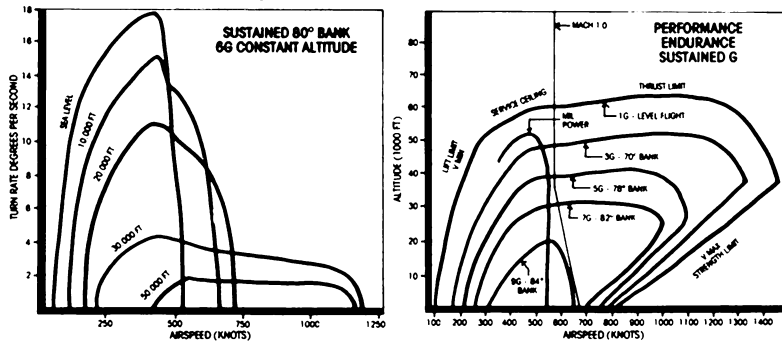

2.4. PERFORMANCE ENVELOPE

An aircraft's performance envelope is the boundary that separates the airspeed/altitude combinations where it can fly from those where it cannot fly. The larger the envelope, the more capable the aircraft.

The aircraft's minimum speed (V_{min}) is governed by the ability of its wings to generate lift at high angles of attack — this is the "lift limit" of the envelope. At higher altitudes, V_{min} decreases because the less dense air has less capacity to support the weight of the aircraft and flight, and therefore requires a greater angle of attack. At any given altitude, V_{min} increases with increased bank angle because of the extra lift that must be generated not only to overcome the aircraft's weight but also to provide a large turning force.

The top of the performance envelope indicates the aircraft's service ceiling. It is limited by the ability of the engines and wings to produce sufficient thrust and lift to keep the aircraft flying. The right side of the performance envelope indicates the aircraft's maximum speed (V_{max}). The maximum speed at altitudes over 36,000 feet is limited by the ability of the engines to generate thrust in the thin air of high altitudes in excess of drag; this is the "thrust limit." An aircraft's maximum possible speed generally increases with increased altitude up to 36,000 feet. This is because up to this altitude, as altitude increases, air temperature and density fall in such a proportion that thrust decreases less than drag.

Above 36,000 feet, air density continues to fall but air temperature remains constant, resulting in a greater decrease in thrust than in drag.

At altitudes below 36,000 feet, maximum speed is limited by the structural strength of the aircraft; this is the "strength limit." Exceeding the Vmax speed for your altitude below 36,000 feet will result in the destruction of your aircraft. CAUTION: You must reduce engine power and sometimes extend your speedbrake to avoid exceeding Vmax in steep dives.

3.0 AIR COMBAT

3.1. THE PHASES OF AIR COMBAT

3.1.1 DETECTION AND IDENTIFICATION

Early detection and positive identification are the keys to surprise, and surprise is the most important contributor to success in air combat. Aircraft (and SAM sites) that emit radar signals may be detected by your Radar Warning Receiver (RWR), which alerts you to their presence by lighting the first warning indicator on the instrument panel. The hot exhausts of air or ground launched missiles may be detected by your Infra-red Warning Receiver (IRWR), which alerts you to their presence by lighting the second warning indicator on the instrument panel. Your search and tracking radar detects all aircraft up to 60 degrees to the right or left of your flight path and out to 160 miles. Aircraft and missiles detected by your RWR, IRWR, or radar are displayed on the RADAR-ELECTRONIC WARFARE DISPLAY on the instrument panel.

Radar targets may be identified as friendly or hostile electronically, and visual targets may be identified based on the shape of the aircraft. In this simulation, however, all aircraft are hostile and there is no need to identify before engaging. You should, therefore, try to detect hostile aircraft and missiles as far away from your aircraft as possible. You can do this by keeping your radar on the long range scale (unless it is necessary to use the greater resolution of the medium or short range scales to locate close in targets and threats) and continuously scanning the RADAR-ELECTRONIC WARNING DISPLAY for threats.

3.1.2. ATTACK

Once a target has been detected, the attack is planned based on the flight characteristics and offensive and defensive weapons systems of your aircraft, and on the hostile aircraft and the tactical situation. Your aircraft is at least as maneuverable and fast as any adversary aircraft. Some adversary aircraft have performance and weapons systems similar to your F-15, so you generally will not enjoy a significant advantage based solely on your aircraft. Therefore, your analysis of and response to the tactical situation is the key to success

When you detect a hostile aircraft at long range (over 10 miles), make a Medium Range Missile attack. If the target is heading toward you, launch the missile at a range of 30 miles. If the target is flying across your flight path, launch at 20 miles. If it is flying away from you, launch at 10 miles. If you launch at a greater distance, your missile will run out of propellant before it reaches the target. If you launch at a shorter distance the radar homing system will not be fully effective when the missile reaches the target.

When you detect a target at medium range (1000 feet to 10 miles), make a Short Range Missile attack. A stern shot is most effective because the heat of the target aircraft's engine exhaust will present the best target. Do not fire when the sun is behind the target.

When you engage a target at short range (less than 1000 feet), the gun is most effective. Your closing speed from astern should be about 50 knots, and not more than 150 knots to avoid overshooting your target. A head-on attack may be made at longer range, up to two miles.

3.1.5 MANEUVER AND DISENGAGEMENT

The first principle of air combat maneuver is energy management. An aircraft at a given altitude and airspeed has an amount of energy equal to the sum of its potential energy (which is proportional to its altitude) and its kinetic energy (which is proportional to the square of its speed). Total energy is increased by increasing engine thrust and is reduced by increasing drag (from steep bank or climb angles or from extending the speedbrake). You may convert potential energy (altitude) into kinetic energy (airspeed) by diving, and you may convert kinetic energy into potential energy by climbing.

Maintaining a high cruise speed (Mach .9) enables you to climb quickly by pitching up; flying at high altitude enables you to accelerate quickly to high speed by diving. Maintain your energy for greatest combat effectiveness.

3.2 AIR COMBAT MANEUVERS

In the maneuver phase of air combat, the attacker seeks to stay behind the defender and to get into position for effective use of his weapons. The defender seeks to disengage or to reverse roles and get behind the attacker. Some common offensive and defensive maneuvers are described below.

3.2.1 OFFENSIVE AIR COMBAT MANEUVERS

HIGH SPEED YOYO: Use when the defender breaks (rolls into a steep bank and turns rapidly) and your speed is too high for you to stay on the inside of his turn to lead him properly (aim ahead of his position).

Reduce your bank angle, pull up into a steep climb, roll inverted over the top of a half loop. When you are in a dive, roll to a steep bank in

the direction of the turn, then pull up to a level turn behind the defender and inside his turn.

LOW SPEED YOYO: Use when you are unable to close within gun range in level flight because the target is as fast as your aircraft.

Push the nose over into a shallow dive, trading altitude for airspeed and gaining on the target. When you are below the target, pull up and fire.

LAG PURSUIT: Use when the defender breaks and your closing speed is too high for you to turn with him.

Maintain your higher speed and your position behind the target, but slide outside his turn, with the same turn rate as the target (in degrees per second), but with a larger turn radius. Be prepared to shoot if he reverses in front of you and be prepared to follow him into a spiral dive.

IMMELMAN: Use to position yourself above the defender or in the proper relation to a ground target.

Pull up into a vertical climb, roll when flying vertically to place yourself in the desired plane of flight, pull back on the stick until you are in level flight inverted, and then roll upright.

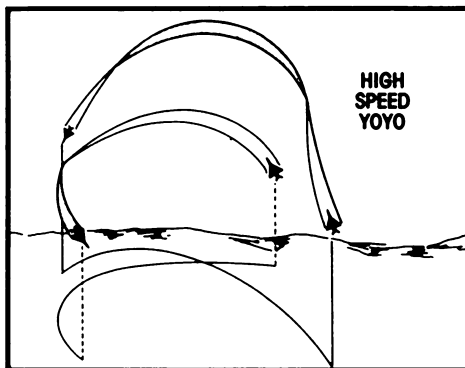

3.2.2 DEFENSIVE AIR COMBAT MANEUVERS

BREAK: Use when an attacker is close behind you with some closing speed.

Roll 90 degrees into the attack (roll to the left if the attacker is on your left) and pull back on the stick to achieve a maximum rate of turn. This will force the attacker to make a maximum angle deflection shot and possibly to overshoot and fly in front of you. You may use the speed-brake briefly to encourage an overshoot, but be careful not to lose too much energy.

REVERSE AND SCISSORS: Use when your break forces the attacker to overshoot and fly in front of you.

With full power, quickly reverse your turn by rolling into a 90 degree bank in the opposite direction from your break. This may position you behind the attacker. You and the attacker may continue to reverse until one of you is in firing position behind the other or disengages.

JINKING: Use when the attacker is within gun range but with little closing speed.

Go to full throttle and afterburner, pull back on the stick briefly, then roll to a different angle and push forward on the stick briefly. Continue this until the attacker has dropped back far enough for you to disengage.

SPIRAL DIVE: Use to disengage when all else has failed, or when you have no remaining offensive weapons.

Maintain the maximum rate of turn (with a 90+ degree bank) in a dive steep enough to maintain a minimum airspeed of 450 knots.

SPLIT S: Use to disengage.

Roll inverted and pull into a vertical dive, then pull out in the opposite direction. Do not exceed maximum speed.

3.2.3. BOMBING TECHNIQUES

DIVE BOMB: Use when flying at medium altitude (4000 to 6000 feet).

Press "B" to arm a stick of bombs and activate the AIR-TO-GROUND RETICLE on the HUD. Maneuver the aircraft to place the target directly ahead of you. When the target is on the AIR-TO-GROUND RETICLE, roll inverted and pull the nose down (if at 6000 feet), or push the nose down (if at 4000 feet) to approximately 30 degrees below the horizon, place the reticle on the target, then roll upright if inverted, keeping the reticle on the target. Release bombs at 2000 feet and pull up immediately.

POP UP: Use when at low altitude (below 1000 feet).

Line up on the target and pull up to 45 degrees above the horizon. Roll inverted at 3000 feet, pull the nose down to 30 degrees below the horizon, place the reticle on the target, then roll upright, keeping the reticle on the target. Release bombs at 2000 feet and pull up immediately.

3.3 THREATS

TOP SECRET

AMERICAN	12	13
C	M	P
A	C	P
S	E	C
A	T	O
A	V	O

3.3.1 AIRCRAFT

MIKOYAN/GUREVICH MIG-21: (Fishbed)

TYPE: Single-seat day fighter.

MAXIMUM SPEED: 1200 knots at 36,000 feet, Mach 2.1; 700 knots at sea level, Mach 1.06.

STALL SPEED: 140 knots.

SERVICE CEILING: 60,000 feet.

RADAR: 16 mile range.

THREAT DETECTION: RWR.

COUNTERMEASURES: None.

ARMAMENT: 23mm gun; four AA-2 Atoll heatseeking missiles.

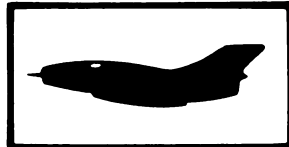

MIKOYAN/GUREVICH MIG-23: (Flogger)

TYPE: Single-seat, all-weather air superiority fighter with secondary ground attack role.

MAXIMUM SPEED: 1260 knots at 36,000 feet; Mach 2.2; 730 knots at sea level, Mach 1.1.

STALL SPEED: Estimated 100 knots.

SERVICE CEILING: 50,000 feet.

RADAR: 50 mile search range, 30 mile tracking range.

THREAT DETECTION: RWR, IRWR.

COUNTERMEASURES: Active radar jammer, chaff, flares.

ARMAMENT: 23mm gun; four AA-2 Atoll heatseeking missiles, or AA-7 Apex heatseeking or radar homing missiles, or AA-8 Aphid heatseeking missiles.

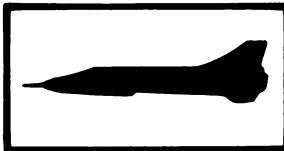

SUKHOI Su-22: (Fitter-C)

TYPE: Single-seat, all-weather, fighter-bomber.

MAXIMUM SPEED: 1380 knots at 36,000 feet, Mach 2.4; 750 knots at sea level, Mach 1.06.

STALL SPEED: 140 knots.

SERVICE CEILING: 60,000 feet.

RADAR: No search radar.

THREAT DETECTION: RWR.

COUNTERMEASURES: Chaff, flares.

ARMAMENT: 30mm gun; four AA-2 Atoll heatseeking missiles, or AA-7 Apex heatseeking or radar homing missiles, or AA-8 Aphid heatseeking missiles.

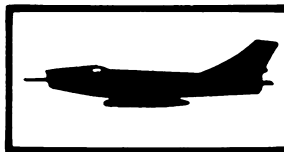

3.3.2 SURFACE TO AIR MISSILES

SA-2: (Guideline)

TYPE: Ground radar guided.

SLANT RANGE: 20 miles.

SPEED: Mach 3.5.

ALTITUDE: 60,000 feet.

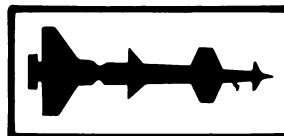

SA-4: (Ganef)

TYPE: Ground radar-guided and semi-active radar homing in terminal phase.

SLANT RANGE: 30 miles.

SPEED: Mach 2.5.

ALTITUDE: 80,000 feet.

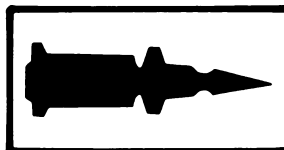

SA-7: (Grail)

TYPE: Hand-held, infra-red.

SLANT RANGE: 5 miles.

SPEED: Estimated Mach 2.

ALTITUDE: 32,000 feet.

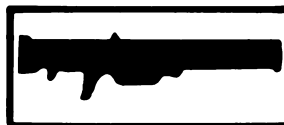

4.0 MISSIONS

The **F-15 STRIKE EAGLE** simulation contains seven missions. Once you have successfully completed one mission, you may fly the next mission, which is more challenging. To complete a mission you must **destroy all primary targets and return to your base**. You may return to base before destroying all primary targets in order to refuel, repair damage, and reload weapons. To return to base, fly over your base at low altitude. (The higher the skill level, the lower you must fly.) The later missions are more challenging because they have more targets and more capable enemy aircraft and SAMs.

4.1 MISSION: LIBYA August 19, 1981.

SITUATION: A U.S. Navy task force including the carrier Nimitz is conducting exercises in the Gulf of Sidra off the coast of Libya. Libyan aircraft have made numerous harrassment flights towards the task force in support of their claim to the Gulf as territorial waters. The U.S. disputes this claim.

FLIGHT PLAN: 1) Daytime, climb to 10,000 feet and fly combat air patrol station; 2) if attacked, engage Libyan aircraft and bomb the air command center (primary target) and airfields; 3) return to base.

THREATS: MiG-21; MiG-23; Su-22.

SIMULATION: You have been attacked by a Su-22 firing a heatseeking missile.

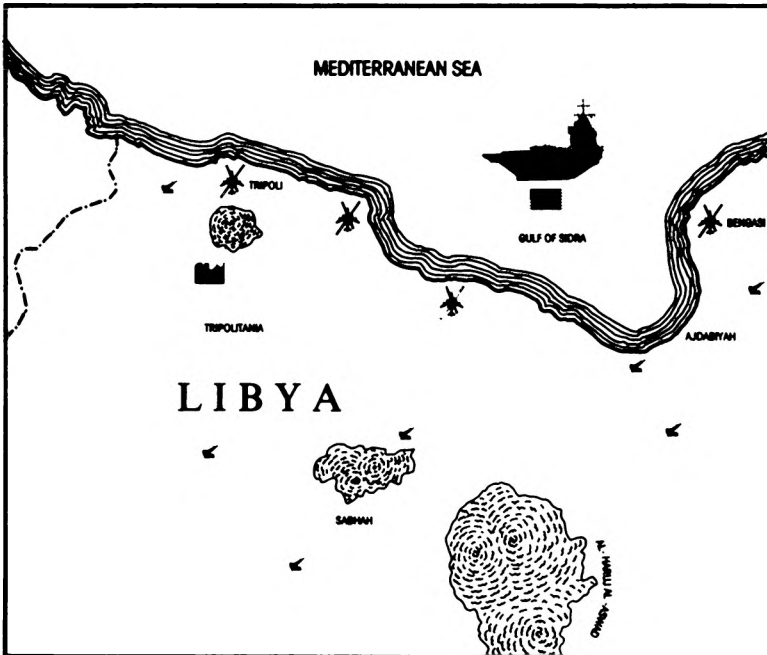

PRIMARY
TARGET



U.S. FLEET



BASE



AIRFIELD



SURFACE
TO AIR
MISSILE
(SAM)

MISSION 2: EGYPT

October 6, 1973.

SITUATION: The Egyptian Army launches the Yom Kippur attack across the Suez Canal. Intelligence has located the Third Army command center. Numerous SAM sites protect the Egyptian front lines and rear areas. The Egyptian Air Force is still active. A risky attack mission has been ordered to disrupt the Third Army HQ.

FLIGHT PLAN: 1) Penetrate air defenses; 2) bomb the command center primary target; 3) bomb as many airfields and SAM sites as possible; 4) return to base.

THREATS: MiG-21; MiG-23; SA-7 (heatseeking SAMs only)



SIMULATION: You are approaching the Suez Canal, you are attacked by a MiG-21|fighter.

MISSION 3: HAIPHONG

April 15, 1972.

SITUATION: After a four year pause, the U.S. resumes intensive bombing of North Vietnamese targets, including military and industrial targets around the port of Haiphong. During the pause, North Vietnamese defenses have been strengthened with radar guided Surface-to-Air missiles and flak batteries. The North Vietnamese air forces are still small. You have been ordered to undertake a precision night bombing raid.

FLIGHT PLAN: 1) Night, penetrate air defenses at 1000 feet or at high altitude; 2) bomb two, primary targets, rail yards, in harbor area; 3) bomb as many SAM sites as possible and any airports if the opportunity arises; 4) return to base.

THREATS: SA-2 and SA-3 radar homing SAMs.

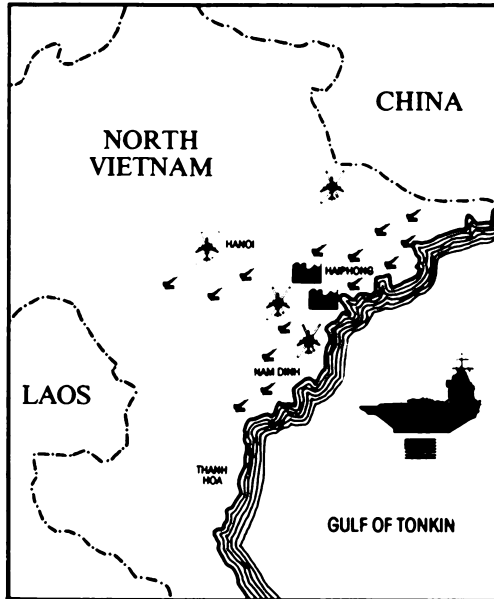

SIMULATION: You are approaching the coast of North Vietnam.

MISSION 4: SYRIA March 12, 1984.

SITUATION: Modern SAM-9 missiles are being deployed by the Syrian army. These dangerous missiles must be identified and destroyed before they become effective. Smaller SAM installations protect these sites as well as Syrian air patrols.

FLIGHT PLAN: 1) Daytime, overfly the Lebanese-Syrian border and identify SAM-9 emplacements; 2) if attacked engage the enemy and bomb the air command center; 3) bomb any SAM sites that fire on you or any air bases that launch aircraft against you; 4) return to base.

THREATS: MiG-21; MiG-23; SA-2 and SA-3 radar homing and SA-7 heatseeking SAMs.

SIMULATION: You have been attacked.

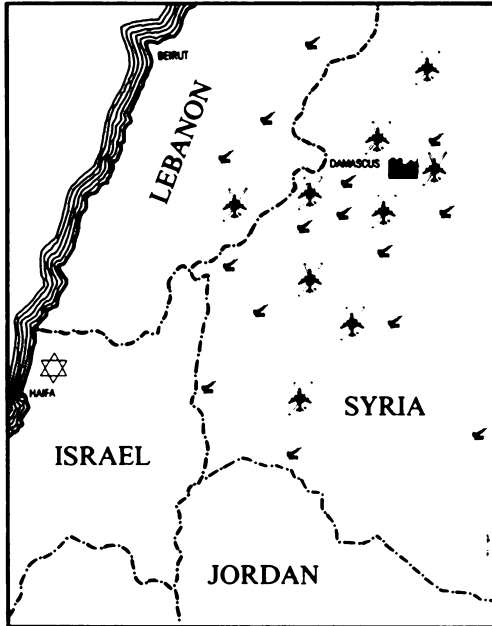

MISSION 5: HANOI May 10, 1972.

SITUATION: Reconnaissance photographs have identified two high priority ground targets deep inside North Vietnam. Defenses include SAM sites and air patrols. A high speed fighter-bomber penetration raid has been ordered.

FLIGHT PLAN: 1) Night, bomb both primary targets, oil storage depots; 2) bomb SAM sites and airfields in the area; 3) return to base.

THREATS: MiG-21; MiG-23.

SIMULATION: You are approaching the coast of North Vietnam.



MISSION 6: IRAQ

June 7, 1981.

SITUATION: The Iraqi nuclear reactor complex, capable of producing weapons grade nuclear material, is nearing completion. A secret strike is planned to eliminate this facility.

FLIGHT PLAN: 1) Penetrate air defenses below 1500 feet to avoid radar detection; 2) bomb reactor; 3) bomb any SAM sites or air bases that could endanger this or a follow-up mission; 4) return to base.

THREATS: SA-2 and SA-3 radar homing and SA-7 heat-seeking SAMs.

SIMULATION: You are approaching the border of Iraq.

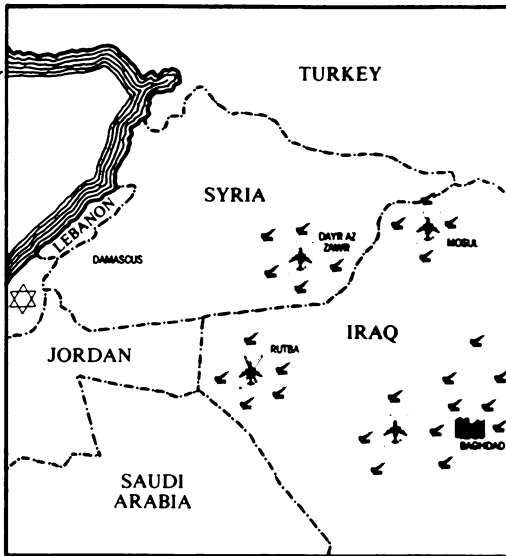

MISSION 7: PERSIAN GULF

June 5, 1984.

SITUATION: Iranian aircraft have been attacking vital Persian Gulf shipping and Saudi Arabian shore installations. Your mission is to patrol the Gulf and intercept hostile aircraft.

FLIGHT PLAN: 1) If attacked, engage enemy aircraft; 2) penetrate airspace at medium altitude; 3) bomb primary targets; 4) bomb SAM sites and airbases endangering this or follow-up missions; 4) return to base.

THREATS: MiG-23; Su-22; SA-4 and SA-6 high performance radar homing and SA-7 heat-seeking SAMs.

SIMULATION: You are approaching an Iranian aircraft.



To The Shores of Tripoli, 1986

The Anti-Terrorist Airstrike

At 1:30 a.m., April 15, 1986, eighteen US Air Force F-111 bombers streaked around Cape Bon, Tunisia, and began the final leg of their 2,800 mile flight. Dropping to just 200 feet above the waves, they lined up for their final approach to the North African coast. Their mission: to attack the Libyan naval station at Sidi Bilal, the military section of Tripoli International Airport, and the military compound at Bab al Azizia, the personal headquarters of Libyan leader Muammar Kaddafi himself.

Meanwhile, five hundred miles to the east, the US Navy carriers America and Coral Sea were launching their A-6, A-7, and F/A-18 attack aircraft. The A-7's and F/A-18's carried HARM and Shrike anti-radar missiles. The A-6's, like the F-111's were equipped with state-of-the-art electronic bombing sights that would enable them to hit targets with pinpoint accuracy in the dead of night. Their mission: to destroy the Libyan's advanced MiG-23 fighters based at Bengasi airfield before they could scramble against the F-111's.

At precisely 1:54 a.m. the A-7's and A/F-18's rose to 500 feet. As Libyan radar locked on to them, they released their missiles, which rode down the radar beams to blind the defenders' electronic eyes. Six minutes later, at precisely 2 a.m., the F-111's and A-6's roared across the coast toward their targets. America's first anti-terrorist airstrike had begun.

These pilots were not the first Americans to fight the Libyans, however. Relations between the US and that Arab nation began to sour as soon as Kaddafi took over the government in 1969 and nationalized American oil interests. They became bitter when the Libyan leader used the profits to finance both expansionist schemes and terrorist activities. Further conflict resulted when Kaddafi laid claim to the entire Gulf of Sidra, a claim rejected by the American government.

In 1981 Libyan fighters attacked American fighters over the Gulf, which led to the clash that inspired F-15 STRIKE EAGLE's first scenario.

The Americans shot down the two attackers and, for the moment, the Libyans ceased to contest control of the Gulf. Kaddafi continued to meddle in the affairs of his neighbors, though, and he continued to sponsor international terrorism. By early 1986, his troops were fighting in Chad, and Libyan backed terrorists had conducted a series of grisly attacks on innocent travellers. They shot up airline ticket counters in Rome and Athens, and amongst their victims were a number of Americans.

The outraged American government resolved to make the sponsor of these assassins pay, and stepped up naval maneuvers in the Gulf of Sidra. When Libyan missile boats attacked, the Americans retaliated by sinking the ships and striking support installations ashore.

A week later, the Libyans responded in turn. A terrorist bomb exploded in a disco full of American soldiers in West Berlin, killing two people and injuring over one hundred others. When America's European allies refused to impose sanctions despite direct evidence of Libyan involvement, the Americans determined to act on their own.

As American preparations for the airstrike began, the British government did agree to allow the F-111's to fly from English bases, but the French and Spanish refused to permit the American bombers to fly over their territory, the direct route to Libya. Consequently, the American planes had to travel an extra 1,500 miles to reach their target.

As the F-111's and A-6's began their bombing runs, the Libyans fired a barrage of SAM-2, -3, -6, and -8 missiles and a hail of shells from ZSU-23-4 anti-aircraft guns. Fortunately, with their radar destroyed, the air defense weapons lost most of their effectiveness. Using precision guided munitions, the F-111's bombed terrorist training facilities, Il-76 transport aircraft that had been used to support terrorist activities, and Kaddafi's personal compound, the nerve center of his government. While Kaddafi himself was not an official target, the Americans hoped at least to unnerve him and perhaps to eliminate him.

As chance would have it, Kaddafi was in a tent somewhat removed from the main compound when the bombs hit, and so escaped injury. Nevertheless, the damage to his headquarters was extensive, and the other airstrikes achieved

similar success. The A-6's destroyed four MiG fighters and two helicopters on the ground, while the F-111's destroyed five transports and damaged the naval facilities at Sidi Bilal. Civilian casualties were relatively light due both to the sophisticated electronics and munitions the bombers used and to the American's instructions not to release their ordinance unless they could identify a target with absolute certainty. American losses were also light: just one F-111 went down in flames, and a second was damaged badly enough that it was forced to make an emergency landing in Spain.

While the airstrike's long term effects are uncertain, it clearly constituted a major technical accomplishment that demonstrated the global reach of American air and seapower.

MISSION 8: THE ANTI-TERRORIST AIRSTRIKE

Libya, April 14-15, 1986

F-15 STRIKE EAGLE was designed long before the anti-terrorist airstrike, yet playing it can give you an appreciation of the skill and bravery exhibited by the American airmen. The mission had three primary features: it was a low level attack, it met intense anti-aircraft defenses, and it was conducted at night. By selecting the scenarios indicated below and following the special instructions, you can recreate each of these essential features of the raid. For maximum realism, try working your way up to a skill level of ACE!

8.1 THE BOMBING RUN

To recreate the bombing run conducted by the American F-111's against Kaddafi's compound, select Mission 1, Libya. Refer to page 32 in the Flight Operations Manual and follow the following flight plan:

- 1) Defeat Libyan interceptor with either your cannon or a short-range missile;
- 2) turn right to head north and descend to below 5,000 feet;
- 3) proceed north until you are well out over the Mediterranean Sea;
- 4) make a descending left hand turn to head south at 1,000 feet;
- 5) set the navigation cursor on Kaddafi's Command Center, the primary target;
- 6) as you cross the coast, drop to 200 feet and engage your afterburner;
- 7) as you approach the target, reduce power to 100%, climb to 500 feet and arm your bomb targeting system;
- 8) release your bombs, rearm your bombs

sight, and release a second stick of bombs on the target; 9) immediately engage afterburners, pull the nose up and climb to 1,200 feet to avoid the blast from your own bombs; 10) to escape and return to the carrier, remain in afterburner and climb to above 40,000 feet or descend again to 200 feet and race northeast toward the carrier.

You can use the same basic approach to recreate the airstrike against the airfield at Bengasi. For the greatest realism, you should return to base after each mission in order to repair and replenish your plane.

8.2 THE ANTI-AIRCRAFT ENVIRONMENT

To experience the intensity of the anti-aircraft defenses the American airmen encountered, select MISSION 6 and attack the primary target as Baghdad using a bombing run similar to that described above in section 8.1.

8.3 NIGHT BOMBING RUN

To conduct a night precision bombing raid like the one the raiders actually carried out, select MISSION 3 and execute a bombing run similar to that described above in section 8.1.

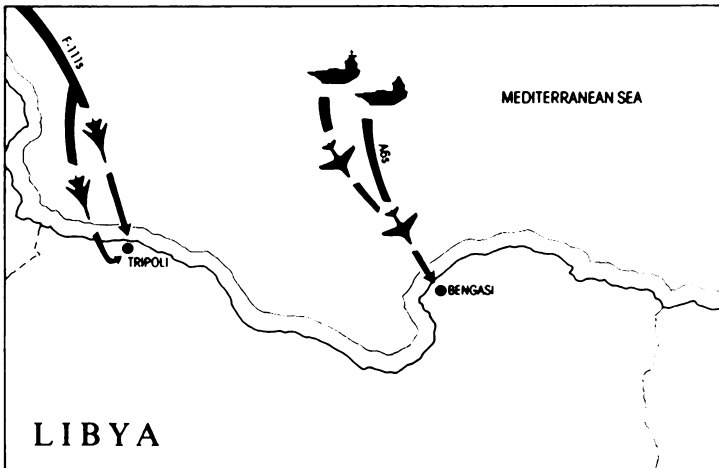

© Copyright 1986, MicroProse Software, Inc.

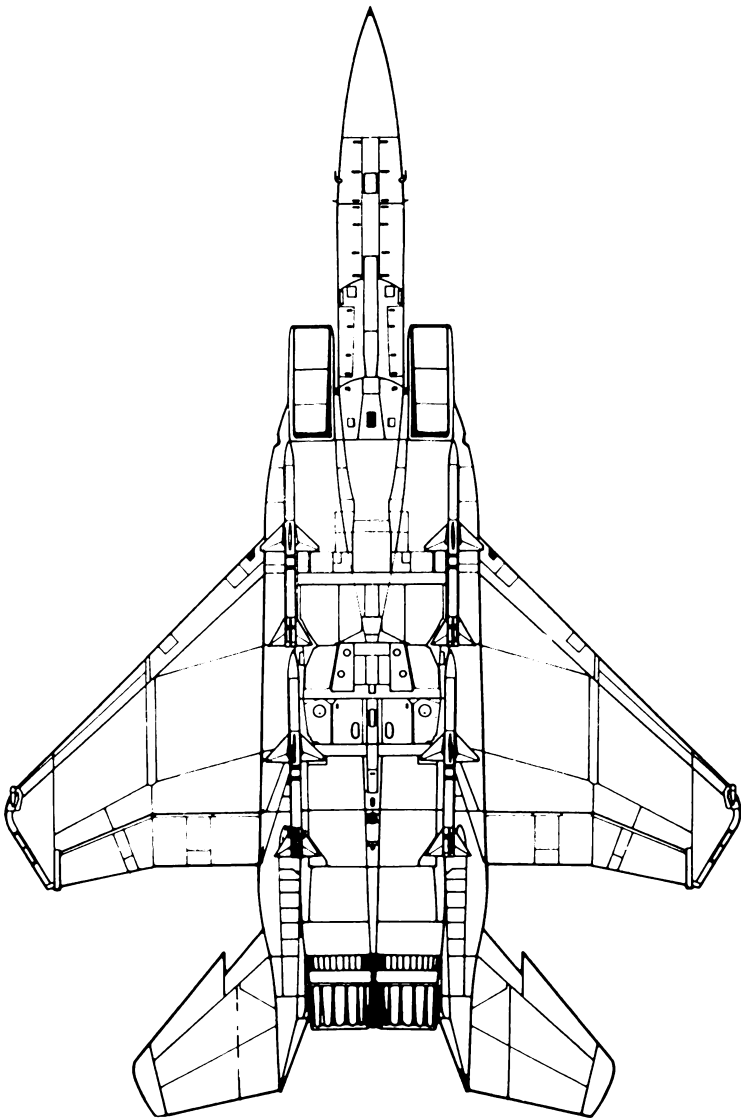

MicroProse remains committed to bringing you high quality, real-life simulations which provide excitement, challenge, and learning. We hope that you will enjoy this product and will consider other MicroProse products in the future.

Software Authors!!

MicroProse is always searching for new people, ideas, and products, so we can bring the most challenging and fun products to our customers. If you are working on or have a good idea for quality entertainment, educational, or utility software, call or write to us!!! We would like to get you on our team and make you a MicroProse partner!!

Portions produced using copyrighted products of Monarch Data Systems and Drive Technology Ltd. APPLE: Operating system is copyrighted by Apple Computer, Inc. Portions also copyrighted by Diversified Software Research, Inc.



2, Market Place, Tetbury, Gloucestershire GL8 8DA
Tel: (0666) 54326
Fax: (0666) 54331 Tlx: 43422MPS UK G